



Bodentürpuffer zum Schrauben





Werkstoff: Edelstahl, Messing

WEBCODE: BDFM Stopper XL

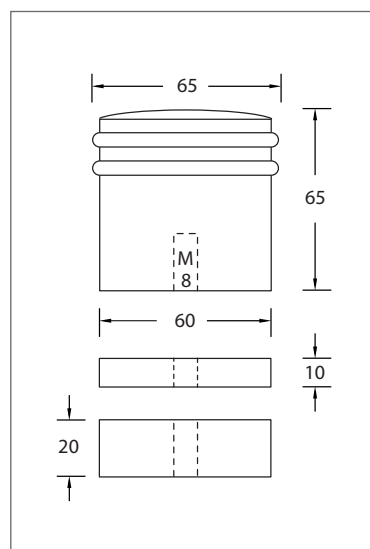
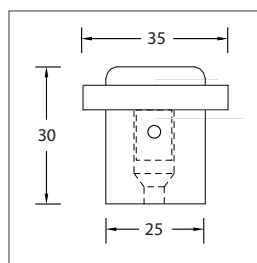
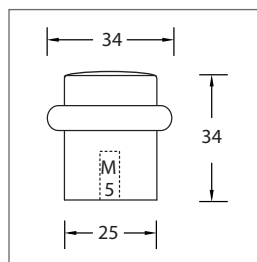
WEBCODE: QBLN Doormigg

WEBCODE: BMTV Doormigg 2



Modell	Bestell-Nr.	Bestell-Nr.	Bestell-Nr.	Bestell-Nr.	Bestell-Nr.
 Bodentürpuffer Stopper XL, mit schwarzem Gummi, inkl. Befestigungsmaterial.	58.51.90	58.51.92	58.51.94	—	—
 Unterlage 60 mm, Höhe 10 mm.	58.52.40	58.52.41	58.52.42	—	—
 Unterlage 60 mm, Höhe 20 mm.	58.51.46	58.52.47	58.52.48	—	—
 Bodentürpuffer Doormigg, mit schwarzem Gummi, inkl. Befestigungsmaterial.	—	—	58.56.03	58.56.07	58.56.17
 Bodentürpuffer Doormigg 2, mit schwarzem Gummi, inkl. Befestigungsmaterial.	1361.32.26	1361.32.28	1361.32.04	—	—

Optionen auf Anfrage:

