

System: Laufschiene für Decken- oder Wandmontage, für 1 Holztür bis 60 bzw. 100 kg Türgewicht. Türstärke 30-40 mm.

WEBCODE: XBYO

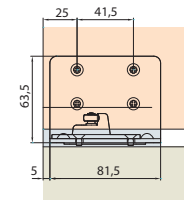
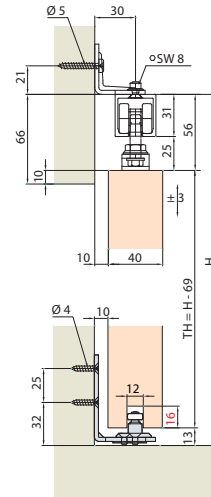
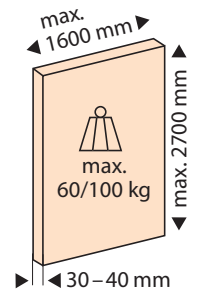

Einbauvariante

Wandmontage mit Einfachlaufschiene, Winkel-Set und Bodenführungs-Set mit Rolle.

Einbaubeispiele:

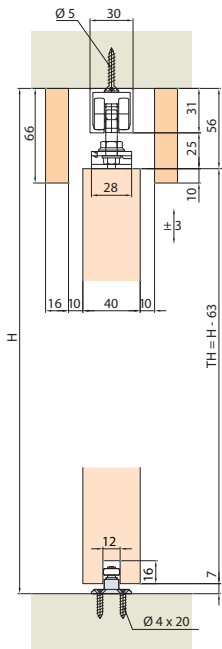

Deckenmontage mit Einfachlaufschiene.

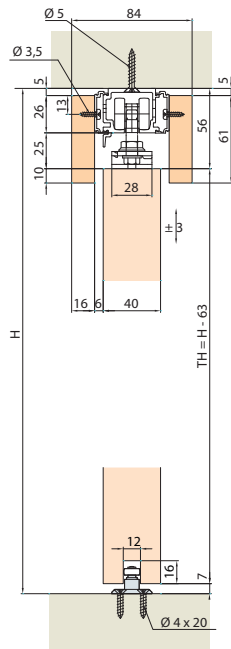



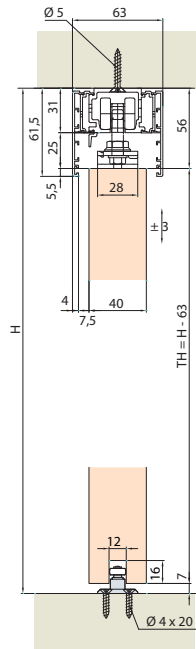

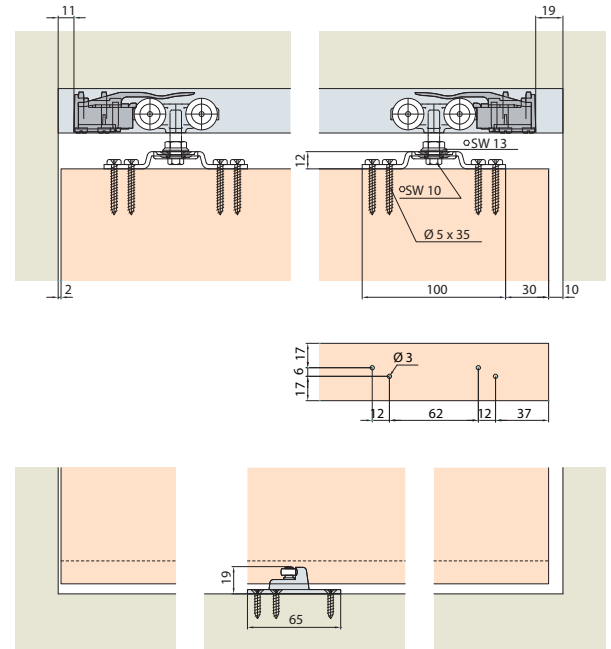

Deckenmontage mit Combi-Laufschiene, Clip-Teil / Holzblende.







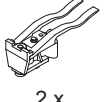

Deckenmontage mit Combi-Laufschiene, Clip-Teil / Clip-Blende Alu.







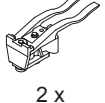

EKU PORTA 60 / 100 H

Garnituren Porta 60 / 100 H ohne Laufschiene							Türgewicht	Bestell-Nr.
1 Tür							60 kg	1354.05.21
	2 x	2 x	2 x	1 x	2 x	Montageanleitung	100 kg	1354.06.21

Einzelteile siehe Katalogseite Einzelteile und Zubehör Porta

Garnitur Porta 60 H mit Laufschiene Alu							Türgewicht	Bestell-Nr.	
1 Tür							2000 mm	60 kg	1354.30.21
	2 x	2 x	2 x	1 x	2 x	Montageanleitung	1 x		

Garnitur Porta 100 H mit Laufschiene Alu eloxiert							Türgewicht	Bestell-Nr.	
1 Tür							2000 mm	100 kg	1354.30.26
	2 x	2 x	2 x	1 x	2 x	Montageanleitung	1 x		

Laufschiene	Länge	Alu	Alu eloxiert
Einfachlaufschiene gelocht H31 x B30 mm Laufschiene aus Stahl siehe Katalogseite Einzelteile und Zubehör Porta	1500 mm	Bestell-Nr. 1354.12.20	Bestell-Nr.
	1700 mm	1354.14.20	
	2000 mm	1354.16.20	1354.16.21
	2500 mm	1354.01.20	1354.01.21
	6000 mm	1354.00.20	1354.00.21

Laufschiene	Länge	Alu
Combi-Laufschiene, gelocht, H41 x B39 mm	2000 mm	1356.40.20
	2500 mm	1356.40.30
	3500 mm	1356.40.35
	6000 mm	1356.40.40

Profile	Länge	Alu eloxiert
Clip-Blende für Combi-Laufschiene H59,5 x B 8 mm	2500 mm	1370.14.45
	3500 mm	1370.14.55
	6000 mm	1370.14.65
Clip-Teil für Holz- und Alublende (alle 500 mm)		1354.40.70

Zubehör, optional	Bestell-Nr.
1. Winkel-Set für Wandmontage, Stahl verzinkt (10 Stück)	1354.03.61
2.) Bodenführungs-Set mit Rolle, für Wandmontage	1354.03.51
3.) Schienenverbindungs-U, gelocht, Stahl verzinkt	1354.03.65

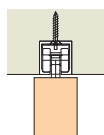
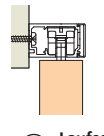
Einzugsdämpfung für 1 Tür, optional		Bestell-Nr.
 <p>A Laufschiene mit Montageöffnung und Abdeckkappe (erlaubt nachträgliche Montage der Einzugsdämpfung durch die Montageöffnung).</p>	 <p>B Laufschiene ohne Montageöffnung und Abdeckkappe (Montage der Einzugsdämpfung sollte stirnseitig erfolgen).</p>	<p>1.) Einzugsdämpfung 1372.30.10</p> <p>2.) Abdeckkappe Montageöffnung 1372.30.50</p> <p>3.) Fräslöhre Montageöffnung 1372.30.95</p> <p>4.) Nutfräser 10 mm, HM 1372.15.08</p> <p>Dämpfen nur in Schließrichtung Nr. 1372.30.10 1 x bestellen</p> <p>Dämpfen in Schließ- und Öffnungsrichtung Nr. 1372.30.10 2 x bestellen</p> <p>Weitere technische Informationen in der Montageanleitung. Video-Anleitung unter http://www.ki-st.de/video/d_bau_001.wmv</p>